

HEAT PUMP

for swimming pool water
heating & cooling

Installation and user manual



HP 900 BLACK Inverter
HP 1100 BLACK Inverter
HP 1500 BLACK Inverter

Version: 01/2022

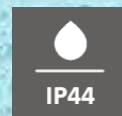



Thank you for purchasing Microwell swimming pool heat pump. Before you use this device, it is necessary to carefully read the entire Installation and user manual. It is not allowed to commence the heat pump installation or operation unless full content of this Installation and user manual is understood and acknowledged. Please keep the Installation and user manual available in the case of any future reference is required. Please provide this information also to each user of the device. Please mind local regulations in your country regarding installation and usage of this heat pump which are valid in addition to this User manual.

Content

1.	INTRODUCTION	3
1.1	Product description	3
1.2	Package checking.....	4
1.3	Waste disposal information	4
2.	SAFETY MEASURES	5
2.1	Electrical safety.....	5
2.2	Usage precautions	5
2.3	Handling precautions	8
2.4	Transportation.....	8
3.	TECHNICAL SPECIFICATION	9
3.1	Technical data.....	9
3.2	Swimming pool water parameters	10
3.3	Heat pump dimensions	10
3.4	Installation instructions.....	11
3.5	Electric wiring diagram	15
4.	REGULATION.....	16
4.1	Description of LED controller	16
4.2	Start-up & Shutdown.....	17
4.3	Mode switch	18
4.4	Defrosting	18
4.5	Temperature setting.....	19
4.6	Setting of timing ON/OFF	20
4.7	Scenario / Operational Mode	21
4.8	Clock setting	22
4.9	Keyboard lock.....	22
4.10	Fault interface	23
4.11	Parameter list and breakdown table.....	24
4.12	Main PCB board (030-P-BP6II).....	28

5. MAINTANANCE & WARRANTY	30
5.1 Maintenance.....	30
5.2 Warranty.....	33

1. INTRODUCTION

In your hands you hold probably the most advanced and the most efficient heat pump currently available on the market. This heat pump provides warm water in your pool at lowest possible cost. The heat pump is manufactured in tightest accordance with related strict standards and norms, in order to provide high quality operation and long-term reliability.

This Installation and user manual contains all the necessary information about the installation, operation and maintenance of the heat pump. Please read this Installation and user manual carefully before you start to use this product. The manufacturer is not responsible for any personal or property damage due to the improper installation, use or maintenance that is not in accordance with this User Manual.

This Installation and user manual is an inseparable part of this product; therefore it must be kept in good condition and must accompany the heat pump.

1.1 Product description

The heat pump is designed exclusively for swimming pool water heating or cooling and maintaining its temperature on the requested level. Other appropriate application is water temperature conditioning for fish tanks, wine ciders or horse cooling facilities. These applications should be discussed with local installer or distributor. Any other form of application is considered inappropriate.

The heat pump achieves the highest efficiency at 15÷35°C air temperature. At ambient air temperatures lower than -7°C the efficiency of the device decreases and at the temperatures higher than +43°C the heat pump can get overheated which may result in its malfunction, damage or failure. Do not use the product out of the designated operational air temperature range which is stated in section Technical data.

The heat pump enables heat gain from the external air surrounding the swimming pool through the compression – expansion cycles of the heat-carrying liquid. The air is driven by a fan through the evaporator where it will deliver its heat to the heat-carrying liquid (the air is being cooled at the same time). The heat-carrying liquid is then delivered to the spirals of the exchanger by the compressor which pressurizes it and thus heats it up. In these spirals, the heat-carrying liquid delivers its heat to the swimming pool water. From the exchanger there is a cooled liquid flowing to the expansion valve or capillary where its pressure decreases and it gets cooled down rapidly at the same time. This cooled liquid flows to the evaporator again where it gets heated by the flowing air. The whole process runs fully automatically and is monitored by the pressure and temperature sensors. The same principle is applied when heat pump operates in cooling mode.

Using simple language, a heat pump is able to extract the heat/cold that is present in ambient environment and leveraged pass it into the pool water. When heating, higher the ambient air temperature is, more free energy can the heat pump extract and thus reach higher efficiency. At favorable conditions you pay around 15% of heat, i.e. 85% of heat is free. Please review below drawing of different ambient air conditions with subsequent efficiencies.

The heat pump efficiency grows by the increasing surrounding air temperature.

It takes some days to achieve the requested swimming pool water temperature. This time period depends on heat loss and heat gain balance of your pool.

Example factors of heat losses: poor pool construction, used materials, usage of cover, air – water temperature relationship, fresh water refilling, filtration, etc.

Example factors of heat gains: intensity of sun, winds, orientation of pool, air – water temperature relationship, etc.

In order to avoid heat loss when the swimming pool is not being used, it is highly advised to use pool's cover.

Ideal water temperature for external pools is considered at levels from 27° to 32°C. This may change based on particular demands of the user. When setting the desired air temperature higher than 32°C please review the material characteristics of your pool parts. High water temperature can damage these materials and contribute to creation of algae. Manufacturer, distributor and reseller do not bear responsibility resulting from inappropriate heat pump usage.

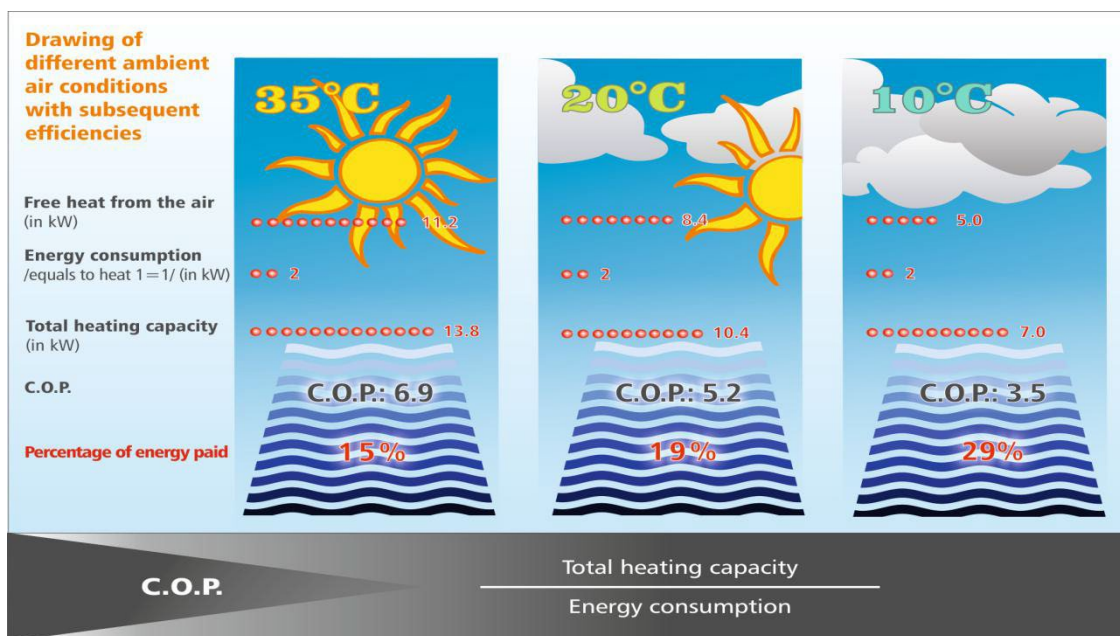

1.2 Package checking

The unit was delivered in carton box on a wooden palette. Do not accept the package if it shows signs of damage. If the package appears intact, please unpack the unit and check the content. It should include the following:

1. The heat pump – condensing unit, the heat exchanger.
2. This Installation and user manual
3. Four rubber silent blocks

1.3 Waste disposal information

When using this heat pump in the European countries, the following information must be followed:

DISPOSAL: Do not dispose this product as unsorted municipal waste. It is prohibited to dispose this heat pump in domestic / household waste. It is prohibited to dispose this appliance into forests or natural landscape. This could lead into local soil pollution. Collection of such waste must be treated individually.



DISPOSAL POSSIBILITIES:

1. The municipality has established a collection system where electronic waste can be disposed.
2. When buying a new product, the retailer or the manufacturer may take back the old appliance free of charge.
3. Old appliance may contain valuable resources which could be sold to scrap material dealers.
4. Disposal of packaging materials such as carton box or plastic / bubble foil can be recycled.



2. SAFETY MEASURES

It is necessary to follow instructions in this Installation and user manual and local regulations in your country that regulate the installation and usage of this device. Incorrect, improper or operations contradictory to this Installation and user manual may lead to an injury or property damage and will lead to loss of warranty. To prevent injury or property damage the following instructions must be followed:

2.1 Electrical safety

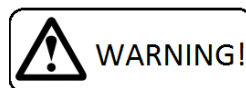

- *The device operates at dangerous electrical current.*
- *Only authorized person with particular electro-technical qualification can manipulate with unit.*
- *Danger of electrical shock.*
- *Do not exceed the required power supply.*
- *Do not turn the device on that shows signs of possible damage such as broken packaging, broken or otherwise damaged unit's chassis or cover, smoke, smell, etc.*
- *It is necessary to use appropriate Residual current circuit breaker (RCD) for connection of the heat pump to main power supply.*
- *Do not manipulate with the device with wet hands.*
- *Do not clean the device with water.*
- *Before cleaning the device, switch off the circuit breaker of the unit's power supply.*
- *Installation, service or repair must be performed by qualified technician.*
- *When the device is not intended to be used for a longer time, we recommend switching the circuit breaker of the unit's power supply off.*
- *Unit must be installed in vertical position to avoid condensate water to enter electrical part of the unit.*
- *It is forbidden to install the unit close to devices that may cause electrical or frequency disturbance such as welding machines, motors or rotors, WIFI/WLAN routers or repeaters.*
- *It is forbidden to alter electrical installation of the device. It is also forbidden to alter any other part or functionality of the device.*

2.2 Usage precautions

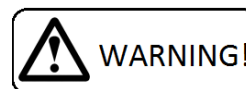

Do not cover or block the intake or exhaust opening / ventilator and evaporator covers. It is forbidden to block or cover the intake or exhaust openings with clothes, towels, buckets, canoes, trees, etc. Such action would lead to a decrease of needed airflow. That would result in heat pump inefficiency and underperformance, eventually to heat pump overheat with subsequent security turning off, and malfunction, failure or damage. Especially during bloom months it is highly advised to keep the evaporator fins clean.

- *Do not climb up on or sit on the unit.*
- *Do not place any objects on the top of the unit (e.g. boxes, flower vases, etc.).*
- *Do not spray any flammable substances into the equipment; this might lead to fire.*
- *Do not clean the equipment with aggressive cleaning agents; this might lead to damage or deformations.*
- *When cleaning plastic parts do not use any cleaning agents unsuitable for plastic (household cleaning agents, solvents, bleaching agents, benzene, diluents, rough cleaning powder, cresol, chemical agents). Instead, sweep the heat pump cover with a soft cloth or a sponge.*
- *Never throw or insert any objects into any hose or opening.*
- *The cover is made of metal. Do not manipulate with lighted cigarette, cigarette ashes, or any other kind of fire in vicinity to this part.*
- *Use this device exclusively for the intended purpose, as described in the attached instruction manual. Do not use parts which are not recommended.*
- *Never block the air opening of the product. Protect the air openings from clogging by particles.*
- *Do not drink or use the condensate water drained from the unit. Do not return the water back to the swimming pool. The water may be contaminated with bacteria.*



- Children are not allowed to operate, touch or play with the unit.
- **Children are not allowed to manipulate with packaging, plastic / bubble foil. Risk of suffocation!**
- Prevent the children from injury or harm caused by any manipulation with the unit, its parts or its packaging. Small parts like screws may be swallowed and cause harm to health.
- Do not leave the children in the swimming pool / at the swimming pool unattended.
- The positioning of the heat pump must be in accordance with the STN 33 2000-7-702 standard, i.e. it must be placed at least 3,5 m from the swimming pool's external border.
- For heating/cooling the swimming pool by the heat pump, the filtration pump must run and the water must flow through the heat exchanger.
- Never turn on the heat pump if it is without water and if the filtration device is not operating.
- Protect the heat pump from freezing. Eliminate the water from the filtration and from the heat pump's water heat exchanger and prepare the product for the winter time.
- At low surrounding ambient temperature level (below 10°C) and high relative air humidity level (e.g. after rain, during the night, etc.), the evaporator may get iced up. Heat pump will automatically defreeze itself. Its operations or functionality is not harmed but the efficiency decreases.
- Manufacturer does not bear any responsibility concerning damages caused by inappropriate heat pump selection, installation or application.
- Do not pressurize the water heat exchanger higher than 0.25MPa (2.5bar). By pressure of 0.5MPa (5bar) the water heat exchanger gets irreversibly damaged. It is advised to install a security valve with pressure threshold at 0.25MPa (2.5Bar) before the heat exchanger.
- Do not apply or use water of higher temperature than 45°C in water heat exchanger. Water temperature above 60°C irreversibly damages the water heat exchanger.
- Manufacturer does not bear any responsibility concerning damages caused by inappropriate heat pump performance and/or model selection, installation or application. Heat pump is considered undersized in the case it works usually and in long-term more than 18 hours daily. General warranty void applies for damages on the device or other damages if the device works usually in long-term more than 18 hours daily.
- The heat pump must be correctly sized for its application.
- Refrigerant connection between the water and the condensing unit must comply with local refrigerant regulations. Typically, the refrigerant circuit must be sealed. Manufacturer does not bear any responsibility for damages caused by incorrect refrigerant works.

1) Warning



- a. The WARNING sign denotes a hazard. It calls attention to a procedure, practice, or the like, which, if not correctly performed or adhered to, could result in personal injury or injury to a third party. These signs are rare, but are extremely important.

	<p>a. Keep the heat pump away from fire source.</p>
	<p>b. It must be placed in well ventilated area, indoor or closed area is not allowed.</p>

	c. Repair and disposal must be carried out by trained service personnel
	d. Vacuumize completely before welding. Welding can only be carried out by professional personnel in service center.

2) Attention

- a. Please read the following instructions before installation, use and maintenance.
- b. Installation must be done by professional staff only in accordance with this manual.
- c. A leakage test must be performed after installation.
- d. If a repair is required, please contact the nearest after-sales service center. The repair process must be strictly in accordance with manual. All repair practice by non-professional is prohibited.
- e. Set proper temperature in order to get comfortable water temperature to avoid overheating or overcooling.
- f. Please don't stack substances, which will block air flow near inlet or outlet area, otherwise the efficiency of the heater will be reduced or even stopped.
- g. Don't use or stock combustible gas or liquid such as thinners, paint and fuel to avoid fire.
- h. In order to optimize the heating effect, please install heat preservation insulation on pipes between swimming pool and the heater, and please use a recommended cover on the swimming pool.
- i. Connecting pipes of the swimming pool and the heater should be $\leq 10\text{m}$.

3.) Safety

- a. Please keep the main power supply switch far away from the children.
- b. When a power cut happens during operating, and later the power is restored, the heater will start up.
- c. Please switch off the main power supply in lightening and storm weather to prevent from machine damage that caused by lightning;
- d. Any repairing should be conducted in the area with good ventilation. The ignition source is prohibited during the inspection.
- e. Safety inspection must be carried before the maintenance or repair for heat pumps with R32 gas in order to minimize the risk.
- f. If R32 gas leaks during the installation process, all operations must be stopped immediately and call the service center.

2.3 Handling precautions



- *Transport in lying position or turning the device over may harm the compressor resulting in unit's malfunction, failure or damage and will lead to loss of warranty.*
- *The device must be handled with care and special attention avoiding any mechanical damage.*
- *It is forbidden to apply any improper mechanical force onto the unit. This may cause mechanical damage to the device.*
- *It is forbidden to let the device fall freely onto the ground or any solid surface resulting in hard impact.*
- *Please notify your reseller or distributor if you suspect that the unit was delivered damaged. Unit may seem to work well at start but small damage can make the unit go out-of-order in short time. In such case the unit must be inspected and approved for further use by your reseller.*
- *Please notify your reseller or distributor if directly after installation you suspect that unit is not working in perfect order.*
- *In the case of device failure resulting from improper handling or mechanical damage (impact, hit, fall, etc.), the manufacturer reserves the right to evaluate the continuity of warranty.*

2.4 Transportation

a. Always keep upright

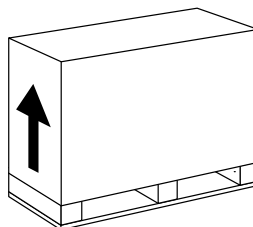

b. Do not lift the water union
(If so, the titanium heat exchanger
inside the heat pump may be damaged)

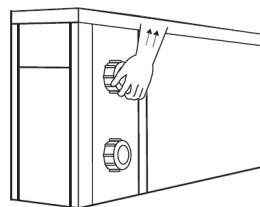

3. TECHNICAL SPECIFICATION

3.1 Technical data

Model	HP900	HP1100	HP1500
AMBIENT TEMPERATURE: 27°C; WATER TEMPERATURE: 26°C, HUMIDITY: 80%			
Heating capacity (kW)	9.0	11.5	15.4
Power input (kW)	0.17-1.55	0.21-1.95	0.27-2.7
COP	10.6-5.8	10.9-5.9	10.7-5.7
AMBIENT TEMPERATURE: 15°C; WATER INLET TEMPERATURE: 26°C, HUMIDITY: 70%			
Heating capacity (kW)	1.3-6.6	1.8-8.6	2.1-11.5
Power input (kW)	0.21-1.57	0.28-1.91	0.33-2.61
COP	6.2~4.2	6.4~4.5	6.3~4.4
AMBIENT TEMPERATURE: 35°C; WATER INLET TEMPERATURE: 32°C			
Cooling capacity (kW)	4.9	6.5	6.7
Power supply	230V/1Ph/ 50Hz		
Running ambient temperature range	-7°C~43°C		
Water temperature range – heating mode	+15°C~+35°C		
Water temperature range – cooling mode	+8°C~+35°C		
Refrigerant	R32		
Sound level at 10m-1m dB(A)	40-49	41-50	43-53
Water pipe connection (mm)	50mm	50mm	50mm
Compressor type	GREE Rotary		
Water flow(m ³ /h)	2.7	3.3	4.4
Net dimension WxHxD (mm)	932x609x377	932x609x377	1015x766x427
Water pipe connection (mm)	50		
Net weight (kg)	43	44	61

* The manufacturer reserves the right to change the parameters without notice.

The refrigerant circuit is filled with R32.

Refrigerant R32 also called HFC-32 or difluoromethane. R32 is a molecule used as refrigerant that has zero ozone depletion potential (ODP).

R32 with the global warming potential (GWP) index 675 times that of carbon dioxide, based on a 100-year time frame, and it is classified as A2L - slightly flammable by ASHRAE.

1. Noise at 1 m, and 10 m in accordance with Directives EN ISO 3741 and EN ISO 354

2. Calculate according to an in-ground private swimming pool covered with bubble

3.2 Swimming pool water parameters

The heat pump is designed for heating the swimming pool water. In order to ensure long term reliability of the heat pump the pool water must be in accordance with the related sanitary requirements.

The limit values for the heat pump operation are the following:

- pH value ranging from 6.8 to 7.9,
- total chlorine amount not exceeding 3 mg/l,
- salt content 6% wt/wt.

Should you have different values of pH, chlorine or salt please try to apply appropriate agents or contact your swimming pool builder to resolve the situation. Above mentioned values are recommended for pools in general.

It is also advised to keep the water hardness on the lower limit of the optimal range, i.e. closely above 8 °N.

3.3 Heat pump dimensions

Model: HP 900/1100 BLACK

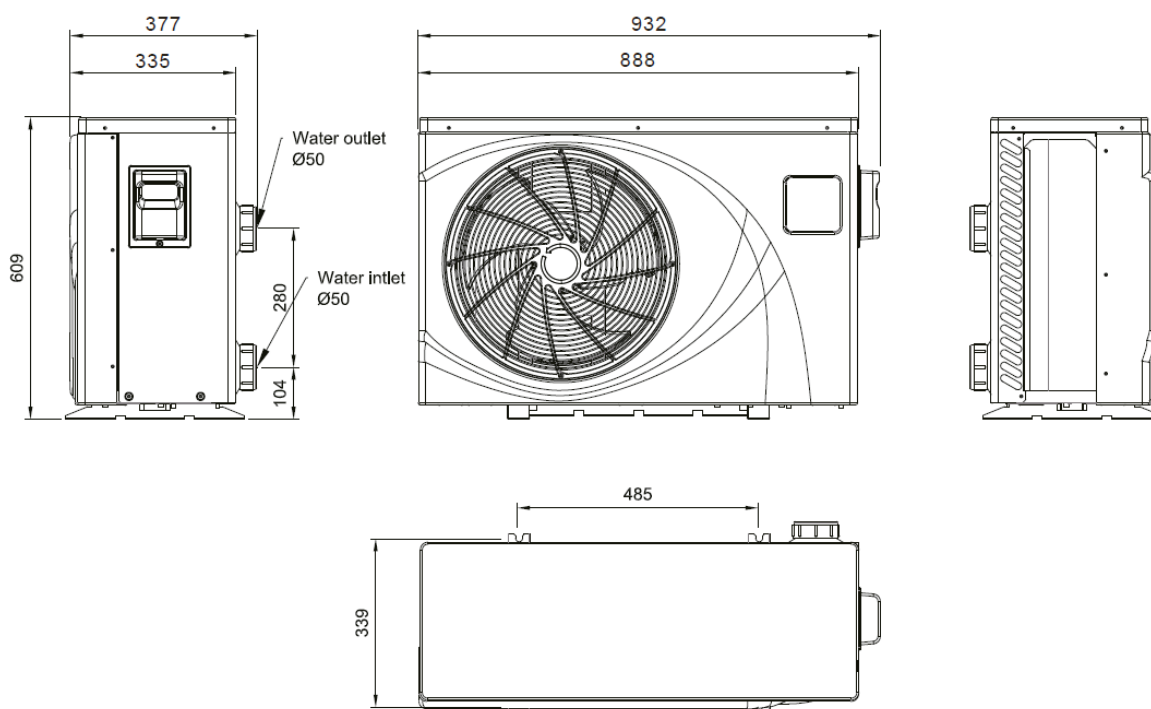

Note: The illustrations and descriptions found in this Installation and user manual are not binding. The manufacturer reserves the right to make corrections or changes without notice.

Model: HP 1500 BLACK

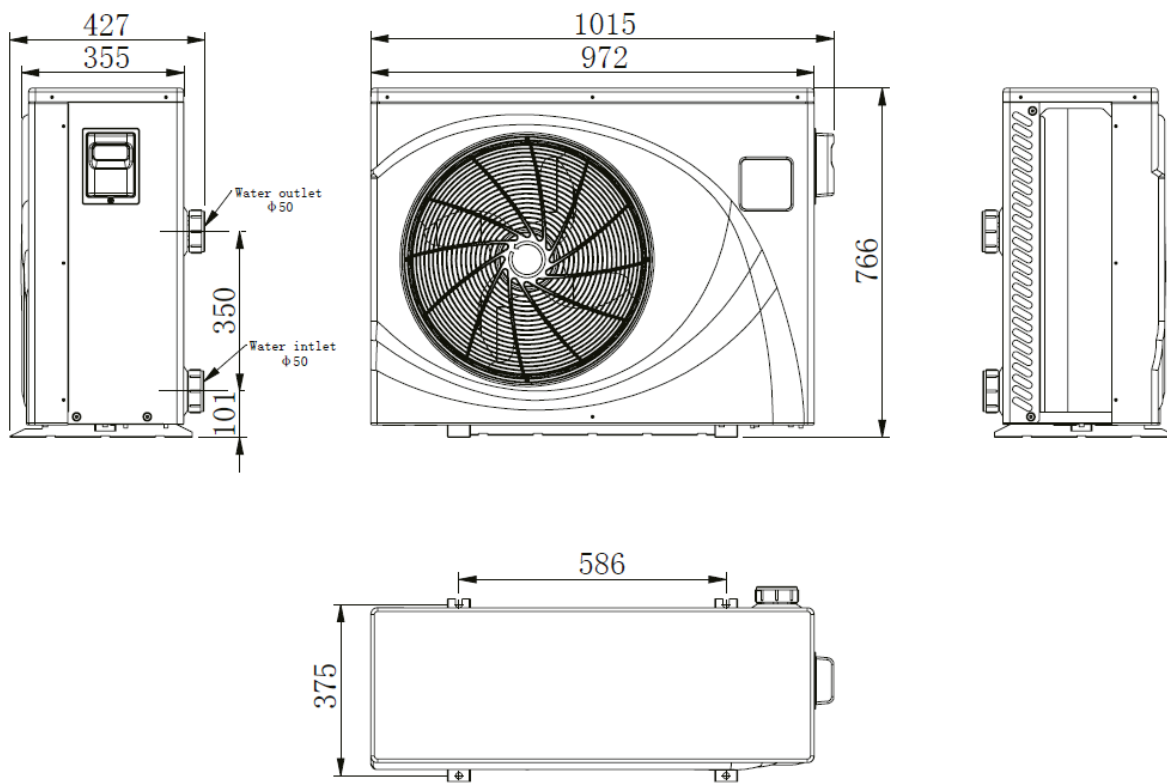

3.4 Installation instructions

WARNING: Installation must be carried out by a qualified engineer.

This section is provided for information purpose only and must be checked and adapted if necessary according to actual installation condition.

a. Swimming pool Heat pumps location

The unit will perform well in any outdoor location provided that the following three factors are presented:

1. Fresh Air - 2. Electricity - 3. Pool filter piping

The unit may be installed virtually anywhere outdoors. For indoor pools please consult the supplier. Unlike a gas heater, it has no draft or pilot light problem in a windy area.

DO NOT place the unit in an enclosed area with a limited air volume, where the units discharge air will be re-circulated.

DO NOT place the unit to shrubs which can block air inlet. These locations deny the unit of a continuous source of fresh air which reduces its efficiency and may prevent adequate heat delivery.

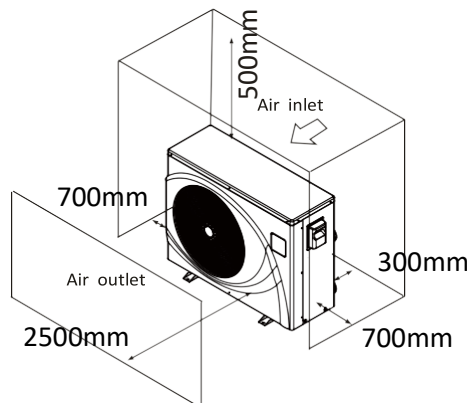

b. How Close To Your Pool?

Normally, the pool heat pump is installed within 7.5 metres of the pool. The longer the distance from the pool, the greater the heat loss from the piping. For the most part, the piping is buried. Therefore, the heat loss is minimal for runs of up to 15 meters (15 meters to and from the pump = 30 meters total), unless the ground is wet or the water table is high. A very rough estimate of heat loss per 30 meters is 0.6 kW-hour, (2000 BTU) for every 5 degree difference in temperature between the pool water and the ground surrounding the pipe, which translates to about 3% to 5% increase in run time.

c. Swimming pool Heat pumps Plumbing

The Swimming Pool Heat Pumps exclusive rated flow titanium heat exchanger requires no special plumbing arrangements except bypass (please set the flow rate according to the nameplate). The water pressure drop is less than 10kPa at max. flow rate. Since there is no residual heat or flame temperatures, the unit does not need copper heat sink piping. PVC pipe can be run straight into the unit. Location: Connect the unit in the pool pump discharge (return) line downstream of all filter and pool pumps, and upstream of any chlorinators, ozonators or chemical pumps. Standard models have slip glue fittings which accept 32mm or 50mm PVC pipe for connection to the pool or spa filtration piping. By using a 50 NB to 40NB you can plumb 40NB.

Give serious consideration to adding a quick coupler fitting at the unit inlet and outlet to allow easy draining of unit for winterizing and to provide easier access should servicing be required.

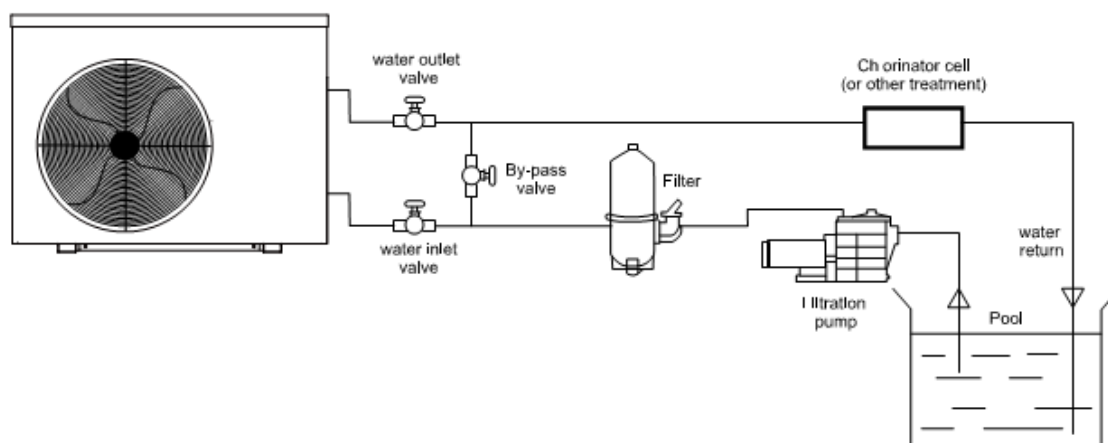
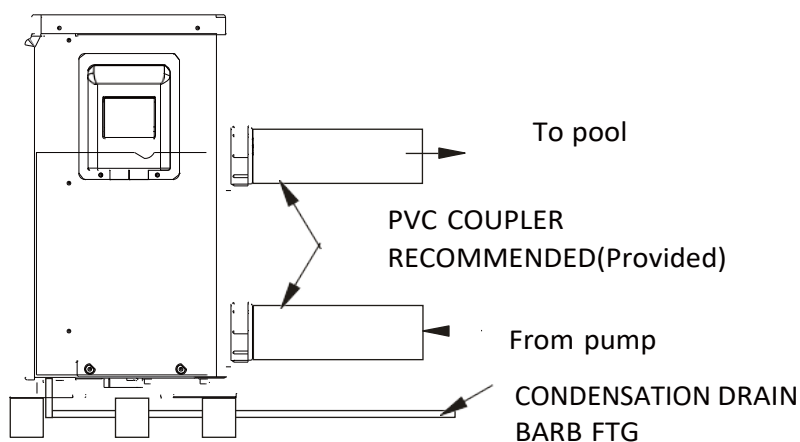

Condensation: Since the Heat pump cools down the air about 4 -5°C, water may condense on the fins of the horseshoe shaped evaporator. If the relative humidity is very high, this could be as much as several litres an hour. The water will run down the fins into the basepan and drain out through the barbed plastic condensation drain fitting on the side of the basepan. This fitting is designed to accept 20mm clear vinyl tubing which can be pushed on by hand and run to a suitable drain. It is easy to mistake the condensation for a water leak inside the unit.

NB: A quick way to verify that the water is condensation is to shut off the unit and keep the pool pump running. If the water stops running out of the basepan, it is condensation. AN EVEN QUICKER WAY IS TO TEST THE DRAIN WATER FOR CHLORINE.

d. Swimming pool Heat pumps wiring

NOTE: Although the unit heat exchanger is electrically isolated from the rest of the unit, it simply prevents the flow of electricity to or from the pool water. Grounding the unit is still required to protect you against short circuits inside the unit. Bonding is also required.

The unit has a separate molded-in junction box with a standard electrical conduit nipple already in place. Just remove the screws and the front panel, feed your supply lines in through the conduit nipple and wire-nut the electric supply wires to the three connections already in the junction box (four connections if three phase). To complete electrical hookup, connect Heat Pump by electrical conduit, UF cable or other suitable means as specified (as permitted by local electrical authorities) to a dedicated AC power supply branch circuit equipped with the proper circuit breaker, disconnect or time delay fuse protection.

Disconnect - A disconnect means (circuit breaker, fused or un-fused switch) should be located within sight of and readily accessible from the unit, this is common practice on commercial and residential air conditioners and heat pumps. It prevents remotely-energizing unattended equipment and permits turning off power at the unit while the unit is being serviced.

e. Initial startup of the Unit

NOTE- In order for the unit to heat the pool or spa, the filter pump must be running to circulate water through the heat exchanger.

Start up Procedure - After installation is completed, you should follow these steps:

1. Turn on your filter pump. Check for water leaks and verify flow to and from the pool.
2. Turn on the electrical power supply to the unit, then press the key ON/OFF of wire controller, It should start in several seconds.
3. After running a few minutes make sure the air leaving the top(side) of the unit is cooler (between 5-10°C).
4. With the unit operating turn the filter pump off. The unit should also turn off automatically.
5. Allow the unit and pool pump to run 24 hours per day until desired pool water temperature is reached. When the water-in temperature reaches this setting, the unit will slow down for a period of time, if the temperature is maintained for 45 minutes the unit will turn off. The unit will now automatically restart (as long as your pool pump is running) when the pool temperature drops more than 0.2 below set temperature.

Time Delay- The unit is equipped with a 3 minute built-in solid state restart delay included to protect control circuit components and to eliminate restart cycling and contactor chatter.

This time delay will automatically restart the unit approximately 3 minutes after each control circuit interruption. Even a brief power interruption will activate the solid state 3 minute restart delay and prevent the unit from starting until the 5 minute countdown is completed.

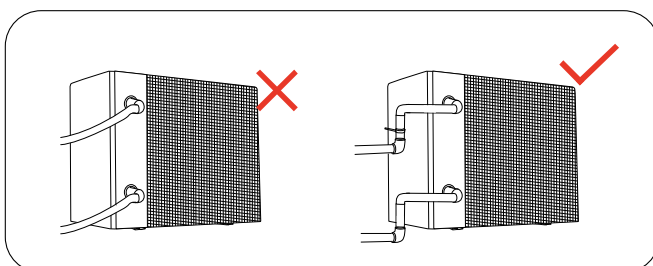

3.5 Electric wiring diagram

WARNING: Power supply of heat pump must be disconnected before any operation.

Please comply with the following instruction to connect heat pump:

- Connect to appropriate power supply; the voltage should comply with the rated voltage of the products.
- Earth the machine well.
- Wiring must be handled by a professional technician according to the circuit diagram.
- Set leakage protector according to the local code for wiring (leakage operating current $\leq 30\text{mA}$).
- The layout of power cable and signal cable should be orderly and not affecting each other.

Electric wiring Diagram - For power supply: 230V 50Hz

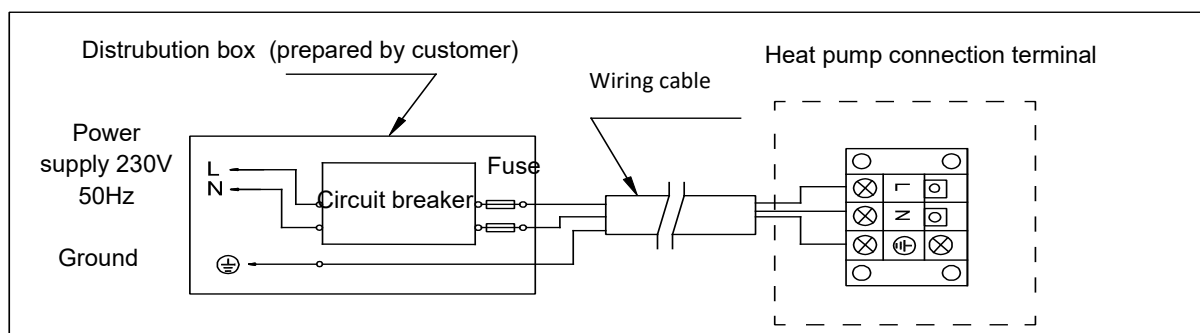

Reference for protecting devices and cable specification

MODEL		HP 900 BLACK Inverter	HP 1100 BLACK Inverter	HP 1500 BLACK Inverter
Circuit breaker	Nominal current (A)	9,13	9,56	14,28
	Rated Residual Action Current (mA)	30	30	30
Fuse (A)		16	16	16
Power cord (mm ²)		3×2.5	3×2.5	3×2.5
Signal cable (mm ²)		3×0.5	3×0.5	3×0.5

※ Above data is subject to modification without notice.

Note: The above data is adapted to power cord $\leq 10\text{m}$. If power cord is $> 10\text{m}$, wire diameter must be increased. The signal cable can be extended to 50m maximum.







4. REGULATION

4.1 Description of LED controller

Control panel appearance



Basic icon	Designation	Function
	Mode key	It is used to switch the unit mode and timing setting.
	On-Off key	It is used to carry out start-up & shutdown, cancel current operation and return to the last level of operation.
	UP key	It is used to page up, and increase variable value.
	DOWN key	It is used to page down, and decrease variable value.
	Setting key	Used to enter the setting interface
	SCENARIO mode	Click to enter the Scenario mode selection interface
	COOLING symbol	It will display during cooling (there is no limit to start-up & shutdown, and it is optional when the unit is cooling-only unit or heating-and-cooling-unit).
	HEATING symbol	It will display during heating (there is no limit to start-up & shutdown, and it is optional when the unit is heating-only unit or heating-and-cooling-unit).
	AUTOMATIC symbol	It will display under the automatic mode (there is no limit to start-up & shutdown, and it is optional when the unit is heating-and-cooling-

		unit).
	DEFROSTING symbol	It will display in the defrosting process of the unit.
	WATER outlet symbol	When the axillary display area displays the water outlet temperature, the light is on.
	WATER inlet symbol	When the main display area displays the water inlet temperature, the light is on.
	SETTING symbol	When the parameter is adjustable, it is on.
	FAULT symbol	In case of unit fault, it is on.
	SCENARIO symbol	Flashes in Settings and turns off when you return to the home screen.

4.2 Start-up & Shutdown

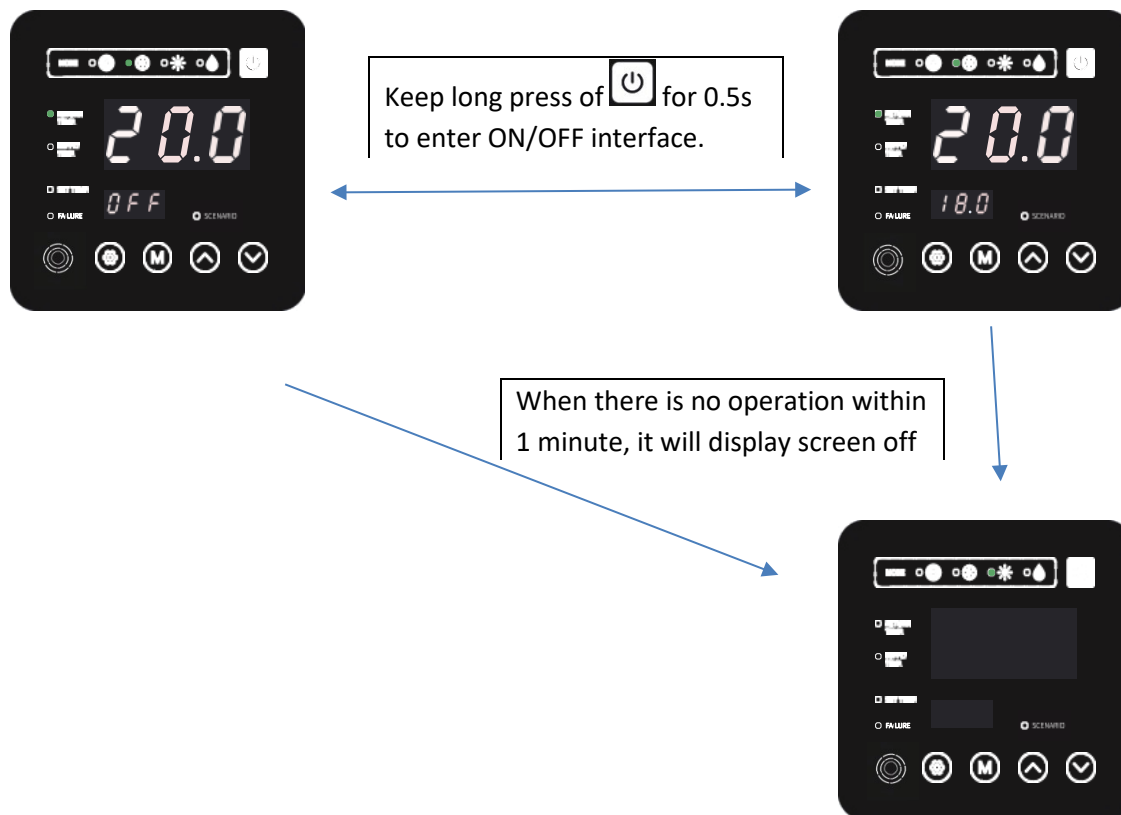

Notes:

Start-up & shutdown operation can only be conducted in the main interface. When it displays full screen off, click any key for returning to ON/OFF main interface.

4.3 Mode switch

Under the main interface, short press  to switch the unit among heating, cooling and automatic mode.

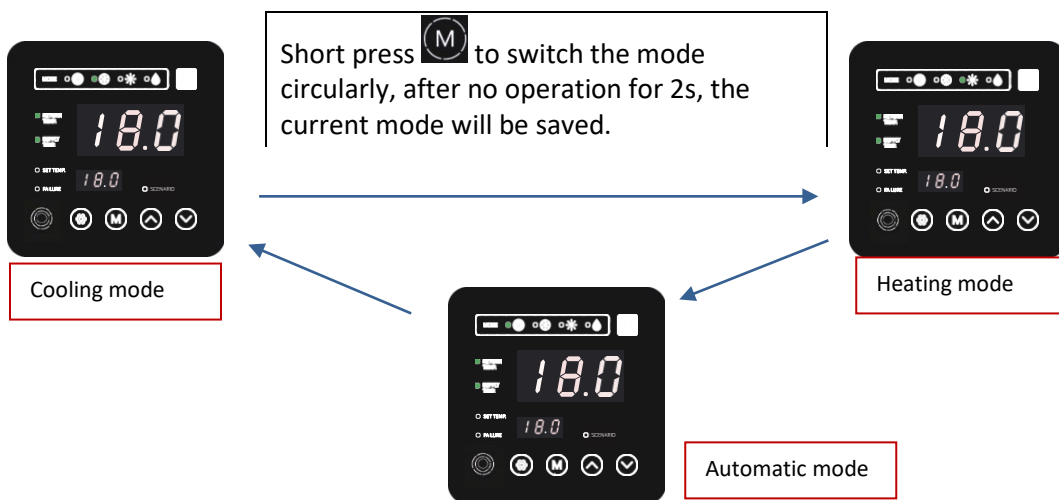

4.4 Defrosting

Mode switch operation can only be conducted in the main interface.

When the unit is under the defrosting state, the defrosting symbol  is on, with the display interface as follows:

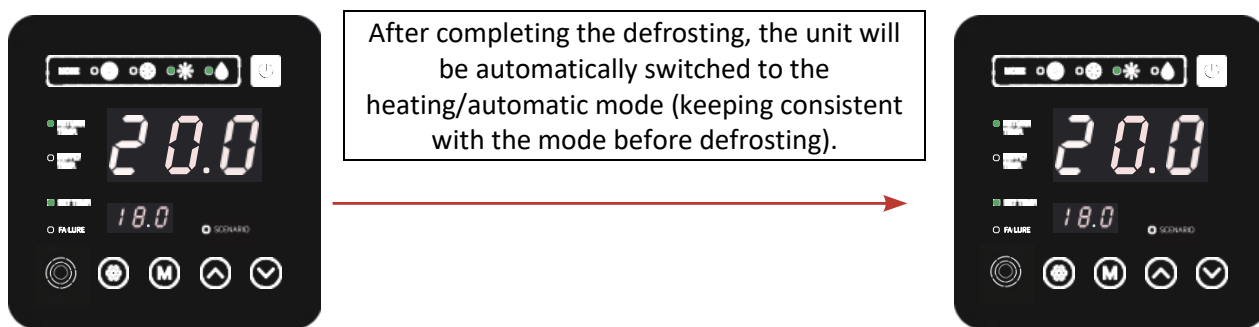

Notes: During the defrosting, mode switch is available. And when switching the mode, the unit won't work under a new mode until defrosting is completed.

4.5 Temperature setting

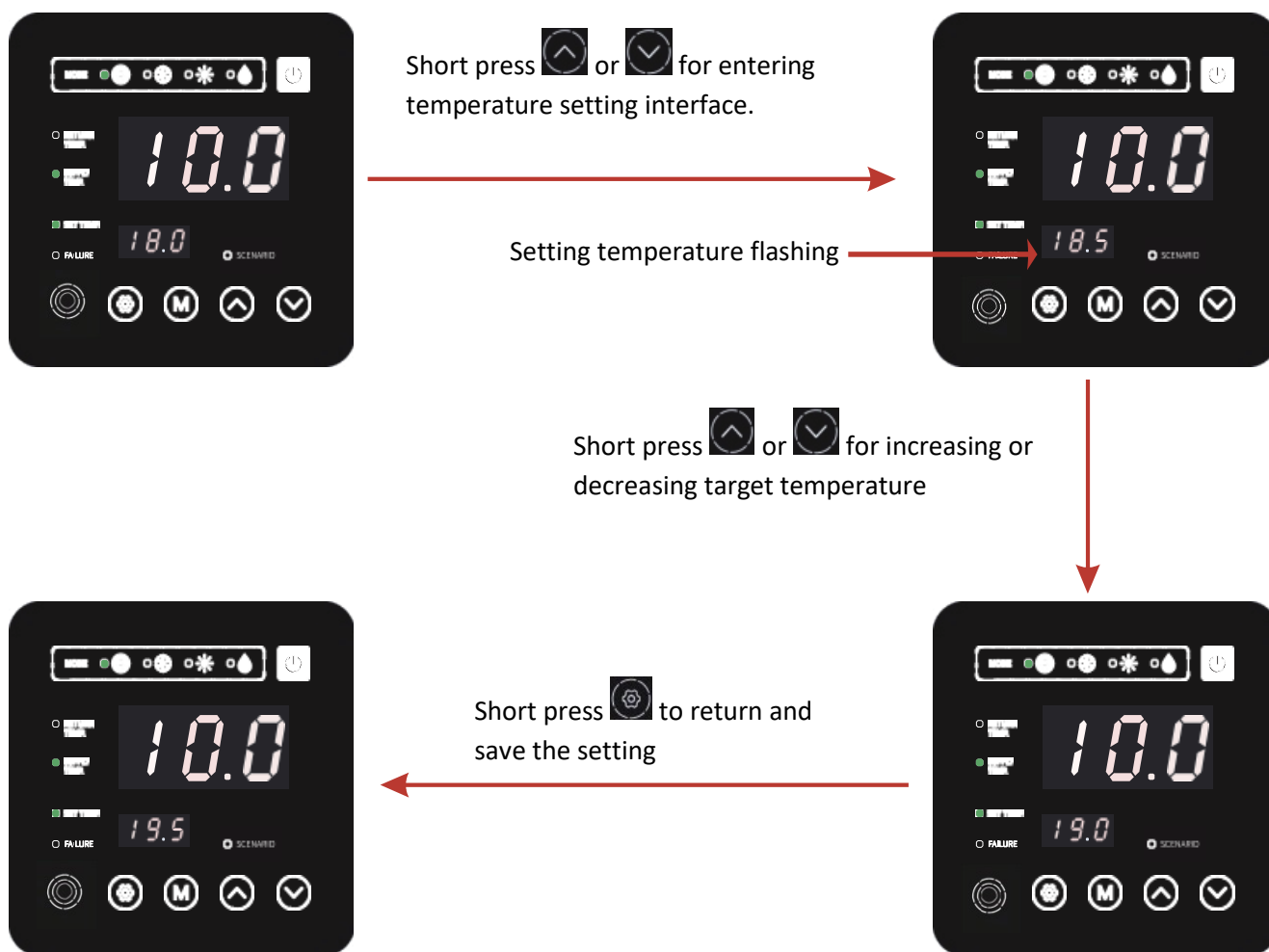

Notes: Under the temperature setting interface, if short press , the system will return to the main interface without any changes saved; If there is no operation for 5s, the system will automatically memorize user's setting, and return to the main interface.

4.6 Setting of timing ON/OFF

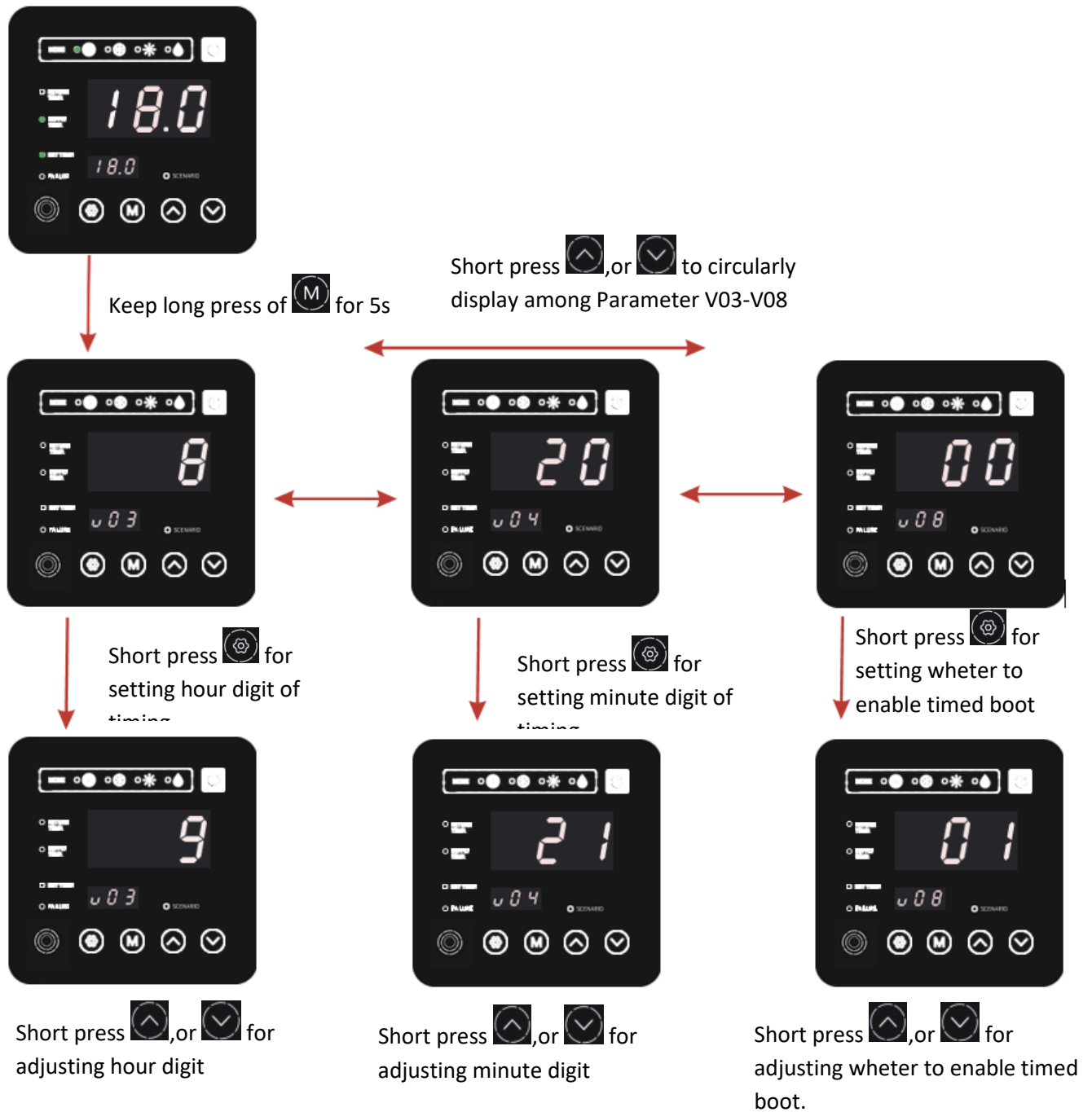

Click **⚙️** to save settings, click **⏻** for returning to the main interface. If there is no operation for 20sec, the system will automatically memorize user's setting, and return to the main interface.

Parameter	Parameter meaning	Parameter range
V03	Hour bit of timing boot 1	0-23
V04	Minute bit of timing boot 1	10/20/30/40/50
V05	Hour bit of timed shutdown 1	0-23
V06	Minute bit of timed shutdown 1	10/20/30/40/50

V07	Whether to enable timed boot 1	0- not enabled, 1- enabled
V08	Whether to enable timed shutdown 1	0- not enabled, 1- enabled



4.7 Scenario / Operational Mode

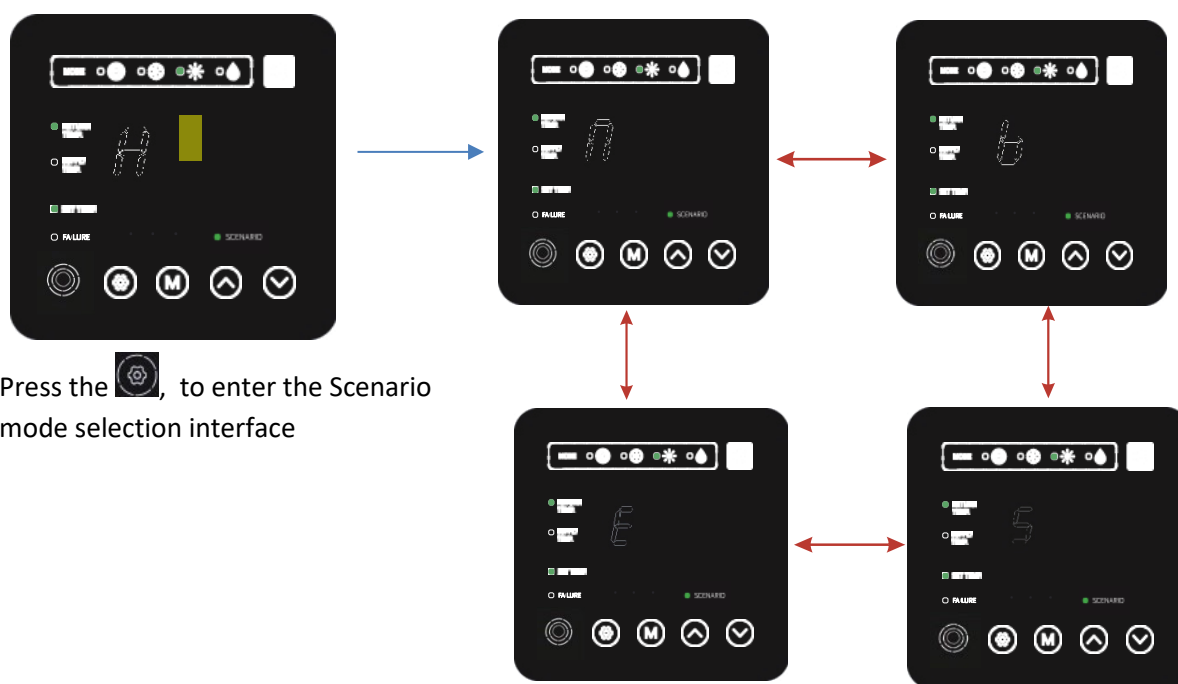

Under the main interface, press  „Scenario mode key“ to enter the Scenario mode selection interface. The current mode flashes and the indicator light flashes.

- BOOST (b)** – The unit is running at full power to reach the required temperature as soon as possible
- SMART (S)**– The unit combines full power with lower speeds as it approaches the desired temperature, or maintains the set temperature only at low speeds.
- EKO (E)**– The efficiency that is maximum for the unit is about 40-70% of the power.
- AUTO (A)** – It combines all previous modes. It maintains the ECO mode while maintaining the required temperature. If there is a large change in temperature, it can operate at full power.





Press the , to enter the Scenario mode selection interface

Short press  or  to switch four modes: AUTO, BOOST, SMART and ECO.

Click  to save settings and return to the main interface (in non-AUTO mode, the indicator light will be on). Under any mode selection, click  to save and return to the main screen.

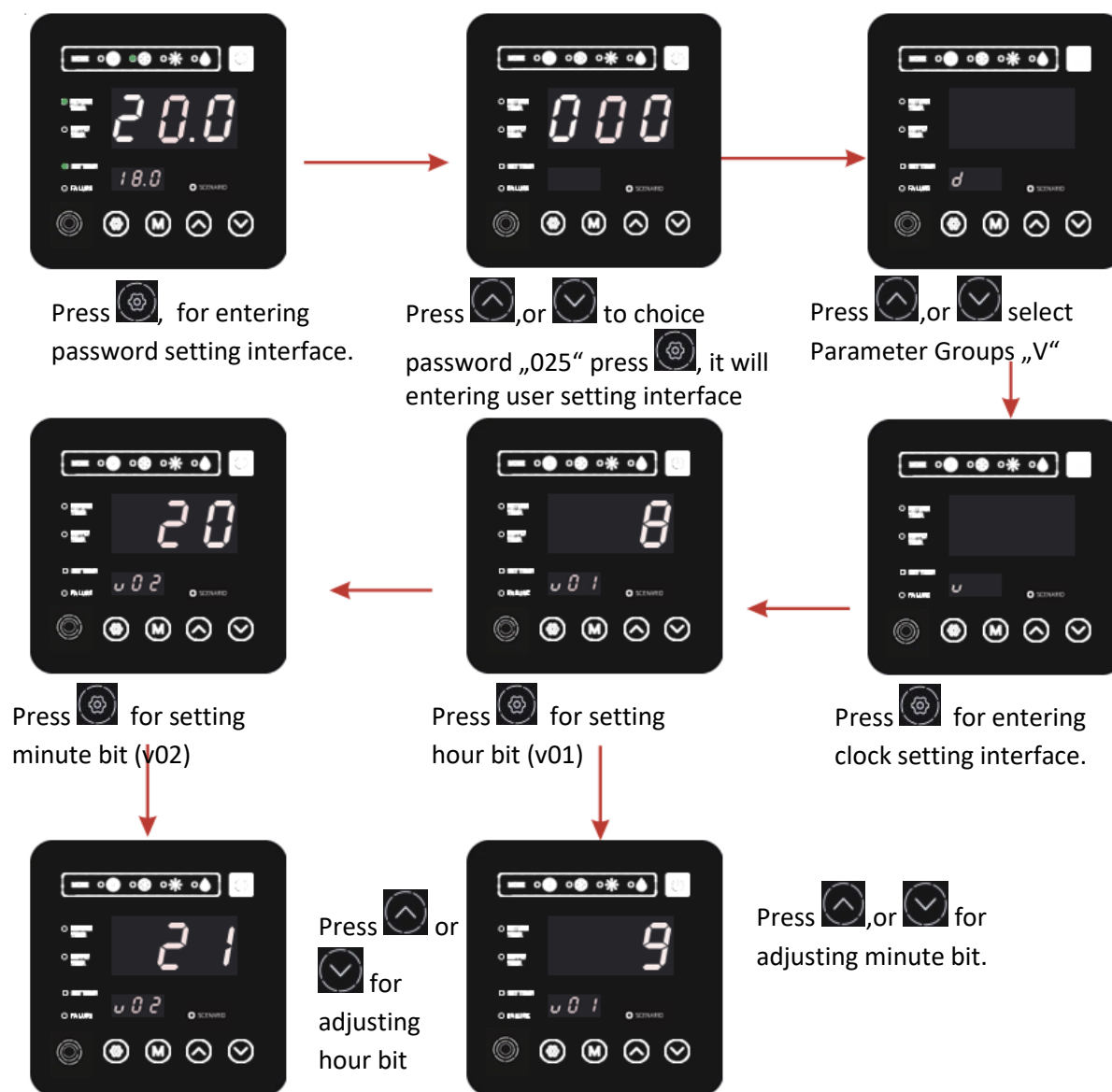
4.8 Clock setting



- 1) Enter settings  (settings button)
- 2) Enter the password "025" (arrows) and confirm with the settings key
- 3) Select parameter "v" and confirm with the setting key
- 4) V01 - clock setting, V02 - minute setting

4.9 Keyboard lock

To avoid others' misoperation, please lock the wire controller after completing the setting.



NOTES:

1. Under the locked screen interface, only unlocking operation is available, and the screen will be lighten after other operations conducted.
2. Under the OFF interface, locking operation is available, and the operation method is the same as locking screen under the ON interface.

4.10 Fault interface

When the unit fails, the wire controller can display the corresponding code according to the fault reason. Refer to the fault table for the specific definition of the fault codes.

For example:

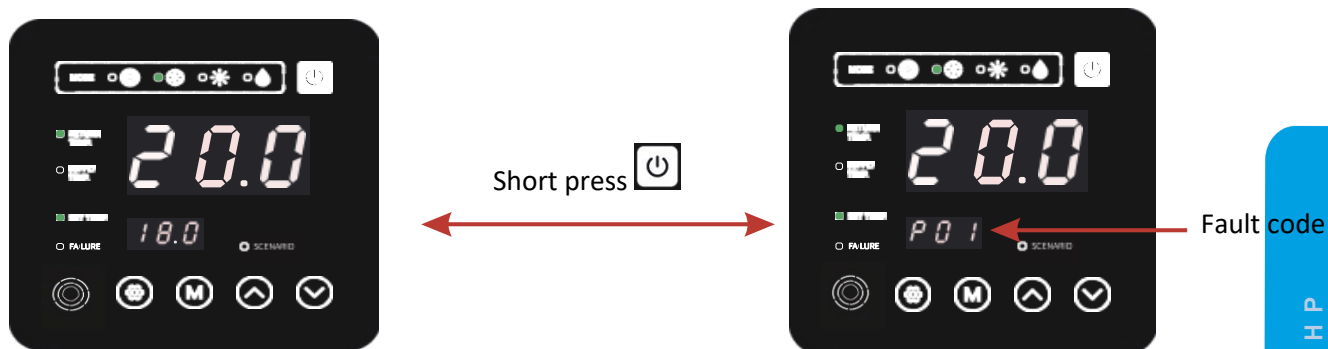

4.11 Operational parameters control

Parameters No.	Meaning
t01	Gas return Temp.
t02	Inlet water Temp.
t03	Outlet water Temp.
t04	Coil Temp.
t05	Ambient Temp.
t06	Exhaust Temp.
t12	Fan Speed
t07-t11, t13-t27	other

Parameters setting instructions:

1. Short press SETTING key and enter into Password interface.

2. Enter password of **025** step by step by pressing UP/DOWN key, then short press SETTING key and enter into setting interface. Enter the digits "0", "2" and "5" one by one and confirm with SETTINGS key.

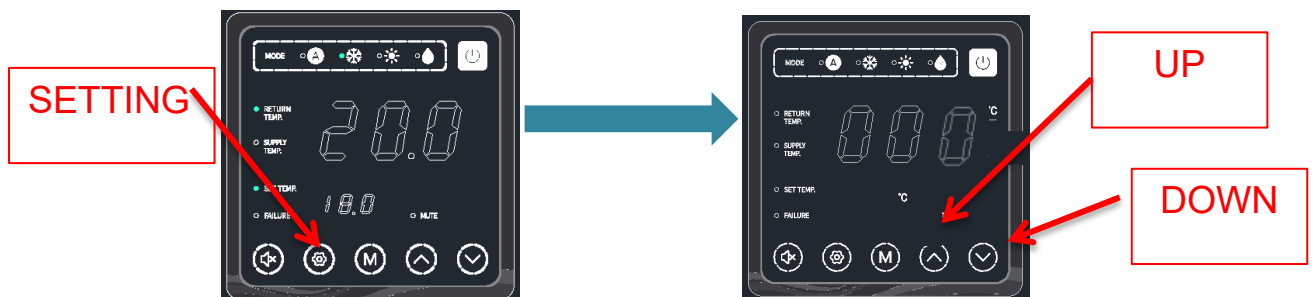

3. You will see "d" parameter. Use UP/DOWN key to switch to parameter "t". Then short press SETTING key and enter into setting interface.

4. By pressing UP/DOWN key, select the parameter and the home page will be flashed. Press UP/DOWN to revise the parameter.

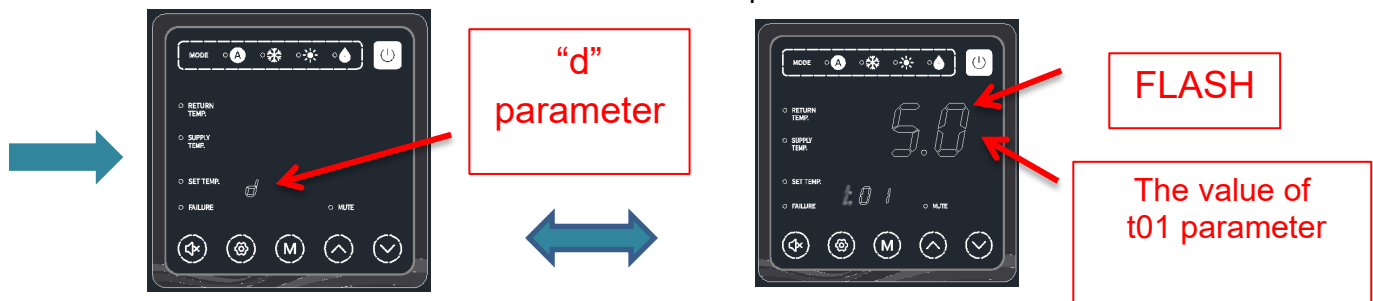

To escape the settings menu press the main On-Off button once or wait 30 seconds. Then you will be prompted to standard display view with Mode (Scenario), current water temperature (big number) and requested water temperature (small number).

“D” Defrosting parameters

Description	Code	Unit.	Default Value	HP Black	Range
Start defrosting temperature	D01	°C	-7	-7	-30~5.0°C
End Defrosting Temp	D02	°C	13	13	0.1~30.0°C
Defrosting Cycle	D03	min	45	45	30~90min
Max. Duration	D04	min	8	8	1~12 min
Defrost type	D06	/	0	0	0-normal/1-eco
Out Temp when Defrost	D07	°C	-30	-30	-30~10.0°C
Compensation offset	D08	°C	10	10	1~50.0°C
Defrost out Temp. Deviation	D09	°C	14	14	1~50.0°C
Defrost ending Temp.	D10	°C	-18.4	-18.4	-30~5.0°C

“P” Water pump parameters

Description	Code	Unit.	Default Value	HP Black	Range
Mode	P01	/	2	2	When P01=0, the circulation pump will keep running when compressor. When P01=1, the circulation pump will stop in 2 min after compressor off. When P01=2, the circulation pump will run at intervals P02 when compressor off.
Interval	P02	min	30	30	0~120min
Duration	P03	min	3	3	0~30min
Advance	P04	min	1	1	0~30min
Whether to enable water pump filtering	P05	/	0	0	0-no/1-yes
Pump filtration start time 1	P06	hour	10	10	0~23h
Pump filter off time 1	P07	hour	12	12	0~23h
Pump filtration start time 2	P08	hour	15	15	0~23h
Pump filter off time 2	P09	hour	17	17	0~23h

Note: **P01=0** Periodical mode (circulation pump on when heating/cooling)
P01=1 Periodical with 2min running after heating/cooling has stopped
P01=2 microEconomy+ (periodical and sleep mode combination)

Please do not perform any changes without consultation with your seller first. Unauthorized changes of the above parameters may result in undesired performance of the heat pump its malfunction or damage. This applies also to system parameters Fxx, Hxx and Rxx.

4.12 Parameter list and breakdown table

Electronic control fault table

Can be read according to the remote controller failure code and troubleshooting

Protect/fault	Fault display	Reason	Elimination methods
Standby	Non		
Normal boot	Non		
Inlet Temp. Sensor Fault	P01	The temp. Sensor is broken or short circuit	Check or change the temp. Sensor
Outlet Temp.Sensor Fault	P02	The temp. Sensor is broken or short circuit	Check or change the temp. Sensor
Amibent Temp.Sensor Fault	P04	The temp. Sensor is broken or short circuit	Check or change the temp. Sensor
Coil Temp.Sensor Fault	P05	The temp. Sensor is broken or short circuit	Check or change the temp. Sensor
Suction Temp.Sensor Fault	P07	The temp. Sensor is broken or short circuit	Check or change the temp. Sensor
Discharge Temp.Sensor Fault	P081	The temp. Sensor is broken or short circuit	Check or change the temp. Sensor
High Pressure Prot.	E01	The high-pressure switch is broken	Check the pressure switch and cold circuit
Low Pressure Prot.	E02	Low pressure protection	Check the pressure switch and cold circuit
Flow Switch Prot.	E03	No water/little water in water system	Check the pipe water flow and water pump, bleed the system from air or increase the water flow. Otherwise contact your service, the flow switch may need to be exchanged.
Anti-freezing Protection	E07	Water temperature in the titanium exchanger is $\leq 4^{\circ}\text{C}$.	Switch the unit to heating mode. The error will be reset automatically if water temperature $\geq 8^{\circ}\text{C}$.
Primary Anti-freezing Prot.	E19	The ambient temp. Is low	
Secondary Anti-freezing Prot.	E29	The ambient temp. Is low	
Inlet and outlet temp. too big	E06	Water flow is not enough and low differential pressure	Check the pipe water flow and whether water system is jammed or not
Low temperature protection	Non	The environment temp. is low	
Comp. Overcurrent Prot.	E051	The compressor is overload	Check whether the system of the compressor running normally
Exhaust Air over Temp Prot.	P082	The compressor is overload	Check whether the system of the compressor running normally
Communication Fault	E08	Communication failure between wire controller and mainboard	Check the wire connection between remote wire controller and main board
Antifreeze Temp. Sensor Fault	P09	Antifreeze temp sensor is broken or short circuited	Check and replace this temp sensor
Waterway Anti-freezing Prot.	E05	Water temp.or ambient temp. is too low	
EC fan feedback Fault	F051	There is something wrong with fan motor and fan motor stops running	Check whether fan motor is broken or locked or not
Pressure sensor Fault	PP	The pressure Sensor is broken	Check or change the pressure Sensor or pressure

Fan Motor1 Fault	F031	1. Motor is in locked-rotor state 2. Wire connection between DC-fan motor module and fan motor is in bad contact	1. Change a new fan motor 2. Check the wire connection and make sure they are in good contact
Low ATProtection	TP	Ambient temp is too low	
Fan Motor Fault	F032	1. Motor is in locked-rotor state 2. Wire connection between DC-fan motor module and fan motor is in bad contact	1. Change a new fan motor. 2. Check the wire connection and make sure they are in good contact.
Communication Fault (speed control module)	E081	Speed control module and main board communication fail	Check the communication connection

Frequency conversion board fault table:

Protection/fault	Fault display	Reason	Elimination methods
DRY MOP alarm	F01	MOP drive alarm	Recovery after the 150s
Inverter offline	F02	Frequency conversion board and main board communication failure	Check the communication connection
IPM protection	F03	IPM modular protection	Recovery after the 150s
Comp. Driver Failure	F04	Lack of phase, step or drive hardware damage	Check the measuring voltage Check frequency conversion board hardware
DC Fan Fault	F05	Motor current feedback open circuit or short circuit	Check whether current return wires connected motor
IPM Overcurrent	F06	IPM Input current is large	Check and adjust the current measurement
Inv. DC Overvoltage	F07	DC bus voltage > Dc bus over-voltage protection value	Check the input voltage measurement
Inv. DC Less voltage	F08	DC bus voltage < Dc bus over-voltage protection value	Check the input voltage measurement
Inv. Input Less volt.	F09	The input voltage is low, causing the input current is high	Check the input voltage measurement
Inv. Input Overvolt.	F10	The input voltage is too high, more than outage protection current RMS	Check the input voltage measurement
Inv. Sampling Volt.	F11	The input voltage sampling fault	Check and adjust the current measurement
Comm. Err DSP-PFC	F12	DSP and PFC connect fault	Check the communication connection
Input Over Cur.	F26	The equipment load is too large	
PFC fault	F27	The PFC circuit protection	Check the PFC switch tube short circuit or not
IPM Over heating	F15	The IPM module is overheat	Check and adjust the current measurement
Weak Magnetic Warn	F16	Compressor magnetic force is not enough	
Inv. Input Out Phase	F17	The input voltage lost phase	Check and measure the voltage adjustment
IPM Sampling Cur.	F18	IPM sampling electricity is fault	Check and adjust the current measurement
Inv. Temp. Probe Fail	F19	Sensor is short circuit or open circuit	Inspect and replace the sensor
Inverter Overheating	F20	The transducer is overheat	Check and adjust the current measurement

Inv. Overheating Warn	F22	Transducer temperature is too high	Check and adjust the current measurement
Comp. OverCur. Warn	F23	Compressor electricity is large	The compressor over-current protection
Input Over Cur. Warn	F24	Input current is too large	Check and adjust the current measurement
EEPROM Error Warn	F25	MCU error	Check whether the chip is damaged Replace the chip
V15V over/under voltage fault	F28	The V15V is overload or undervoltage	Check the V15V input voltage in range 13.5v~16.5v or not

Parameter list:

Meaning	Default	Remarks
Refrigeration target temperature set point	27°C	Adjustable
Heating the target temperature set point	27°C	Adjustable
Automatic target temperature set point	27°C	Adjustable

4.13 Main PCB board (030-P-BP6II)

Controller interface diagram and definition

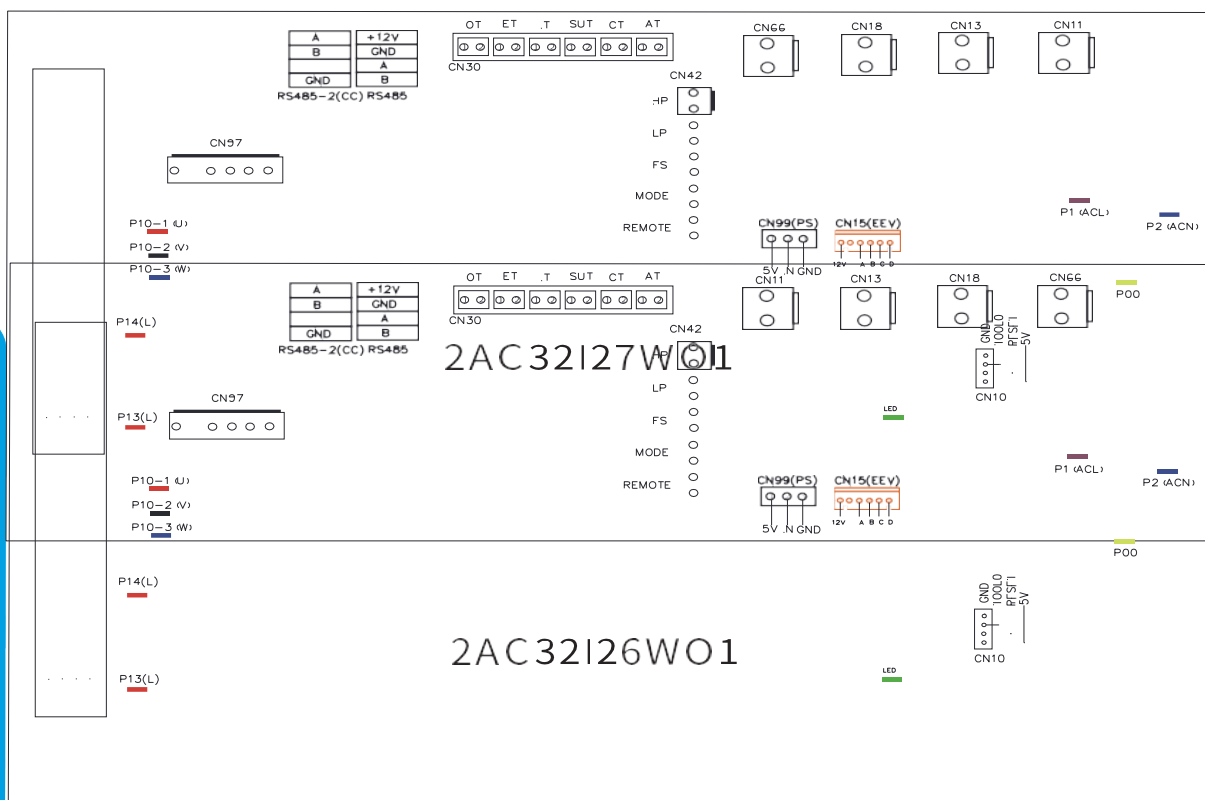

Main board of the input and output interface instructions below

Number	Sign	Meaning
01	P10-1/2/3(U/V/W)	Compressor
02	CN66	Compressor signal
03	CN97	DC motor
04	CN11	4-way valve
05	CN18	Water pump
06	CN13	Reserved
07	P1 P2	Live wire Neutral wire
08	CN10	Program download interface
09	RS485	Color line controller communication
10	RS485-2	The port for centralized control
11	CN15	Electronic expansion valve
12	P13(L)	Resistance
13	P14(L)	Resistance
14	HP	System high pressure
15	LP	System low pressure
16	FS	Water flow switch
17	MODE	Mode switch
18	REMOTE	Emergency switch
19	IT	Water input temperature
20	SUT	System suction temperature
21	CT	System fan coil temperature
22	OT	Water output temperature
23	ET	System Exhaust temperature
24	AT	Ambient temperature
25	CN99	Low pressure sensor



WARNING:

- a. If repair or scrap is required, please contact authorized service center nearby.
- b. Any person who is involved with working on or breaking into a refrigerant circuit should hold a current valid certificate from an industry-accredited assessment authority, which authorizes their competence to handle refrigerants safely in accordance with an industry, recognized assessment specification.
- c. Do not attempt to work on the equipment by yourself. Improper operation may cause danger.
- d. Strictly comply with the manufacturer's requirements when charging R32 gas and equipment maintenance. This chapter focuses on special maintenance requirements for swimming pool heat pump with R32 gas. Please refer to the technical service manual for detailed maintenance operation.
- e. Vacuumize completely before welding. Welding can only be carried out by Professional personnel in service center.

5. MAINTANANCE & WARRANTY

5.1 Maintenance



“CUT OFF” power supply of the heater before cleaning, examination and repairing

1. In winter season when you don't swim:
 - a. Cut off power supply to prevent any machine damage.
 - b. Drain water clear of the machine.

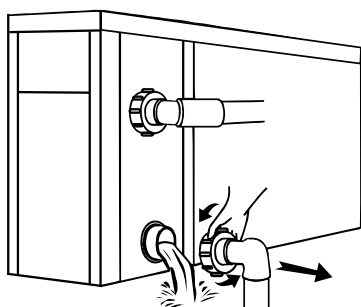

Important:

Unscrew the water nozzle of inlet pipe to let the water flow out.

When the water in machine freezes in winter season, the titanium heat exchanger may be damaged.

- c. Cover the machine body when not in use.

2. Please clean this machine with household detergents or clean water, NEVER use gasoline, thinners or any similar fuel.
3. Check bolts, cables and connections regularly. Check the water supply device and the release often. You should avoid the condition of no water or air entering into system, as this will influence unit's performance and reliability. You should clear the pool/spa filter regularly to avoid damage to the unit as a result of the dirty or clogged filter. Should the unit begin to operate abnormally, switch it off and contact the qualified technician.
4. If repair or scrap is required, please contact authorized service center nearby.
5. Do not attempt to work on the equipment by yourself. Improper operation may cause danger.
6. In case of risking, safety inspection must be carried before the maintenance or repairing for heat pumps with R32 gas.
7. The area around the unit should be dry, clean and well ventilated. Clean the side heating exchanger regularly to maintain good heat exchange as conserve energy.
8. The operation pressure of the refrigerant system should only be serviced by a certified technician.
9. Discharge all water in the water pump and water system, so that freezing of the water in the pump or water system does not occur. You should discharge the water at the bottom of water pump if the unit will not be used for an extended period of time.
10. **Checks to the area.** Prior to beginning work on systems containing flammable refrigerants, safety

checks are necessary to ensure that the risk of ignition is minimised. For repair to the refrigerating system, the following precautions shall be complied with prior to conducting work on the system.

11. **Work procedure.** Work shall be undertaken under a controlled procedure so as to minimise the risk of a flammable gas or vapour being present while the work is being performed.
12. **General work area.** All maintenance staff and others working in the local area shall be instructed on the nature of work being carried out. Work in confined spaces shall be avoided. The area around the workspace shall be sectioned off. Ensure that the conditions within the area have been made safe by control of flammable material.
13. **Checking for presence of refrigerant.** The area shall be checked with an appropriate refrigerant detector prior to and during work, to ensure the technician is aware of potentially flammable atmospheres. Ensure that the leak detection equipment being used is suitable for use with flammable refrigerants, i.e. non-sparking, adequately sealed or intrinsically safe.
14. **Presence of the fire extinguisher.** If any hot work is to be conducted on the refrigeration equipment or any associated parts, appropriate fire extinguishing equipment shall be available to hand. Have a dry powder or CO₂ fire extinguisher adjacent to the charging area.
15. **No ignition sources.** No person carrying out work in relation to a refrigeration system which involves exposing any pipe work that contains or has contained flammable refrigerant shall use any sources of ignition in such a manner that it may lead to the risk of fire or explosion. All possible ignition sources, including cigarette smoking, should be kept sufficiently far away from the site of installation, repairing, removing and disposal, during which flammable refrigerant can possibly be released to the surrounding space. Prior to work taking place, the area around the equipment is to be surveyed to make sure that there are no flammable hazards or ignition risks. „No Smoking“ signs shall be displayed.
16. **Ventilated area.** Ensure that the area is open or that it is adequately ventilated before breaking into the system or conducting any hot work. A degree of ventilation shall continue during the period that the work is carried out. The ventilation should safely disperse any released refrigerant and preferably expel it externally into the atmosphere.
17. **Checks to the refrigeration equipment.** Where electrical components are being changed, they shall be fit for the purpose and to the correct specification. At all times the manufacturer's maintenance and service guidelines shall be followed. If in doubt consult the manufacturer's technical department for assistance.

The following checks shall be applied to installations using flammable refrigerants:

- The charge size is in accordance with the room size within which the refrigerant containing parts are installed;
 - The ventilation machinery and outlets are operating adequately and are not obstructed;
 - If an indirect refrigerating circuit is being used, the secondary circuit shall be checked for the presence of refrigerant;
 - Marking to the equipment continues to be visible and legible. Markings and signs that are illegible shall be corrected;
 - Refrigeration pipe or components are installed in a position where they are unlikely to be exposed to any substance which may corrode refrigerant containing components, unless the components are constructed of materials which are inherently resistant to being corroded or are suitably protected against being so corroded.
19. **Checks to electrical devices.** Repair and maintenance to electrical components shall include initial safety checks and component inspection procedures. If a fault exists that could compromise safety, then no electrical supply shall be connected to the circuit until it is

satisfactorily dealt with. If the fault cannot be corrected immediately but it is necessary to continue operation, an adequate temporary solution shall be used. This shall be reported to the owner of the equipment so all parties are advised. Initial safety checks shall include:

- That capacitors are discharged: this shall be done in a safe manner to avoid possibility of sparking;
 - That there are no live electrical components and wiring are exposed while charging, recovering or purging the system;
 - That there is continuity of earth bonding.
20. **Repair to intrinsically safe components.** Do not apply any permanent inductive or capacitance loads to the circuit without ensuring that this will not exceed the permissible voltage and current permitted for the equipment in use. Intrinsically safe components are the only types that can be worked on while live in the presence of a flammable atmosphere. The test apparatus shall be at the correct rating. Replace components only with parts specified by the manufacturer. Other parts may result in the ignition of refrigerant in the atmosphere from a leak.
21. **Cabling.** Check that the cabling will not be subject to wear, corrosion, excessive pressure, vibration, sharp edges or any other adverse environmental effects. The check shall also take into account the effects of aging or continual vibration from sources such as compressors or fans.
22. **Recovery.** When removing refrigerant from a system, either for servicing or decommissioning, it is recommended good practice that all refrigerants are removed safely. When transferring refrigerant into cylinders, ensure that only appropriate refrigerant recovery cylinders are employed. Ensure that the correct number of cylinders for holding the total system charge is available. All cylinders to be used are designated for the recovered refrigerant and labelled for that refrigerant (i.e. special cylinders for the recovery of refrigerant). Cylinders shall be complete with pressure relief valve and associated shut-off valves in good working order. Empty recovery cylinders are evacuated and, if possible, cooled before recovery occurs.

The recovery equipment shall be in good working order with a set of instructions concerning the equipment that is at hand and shall be suitable for the recovery of flammable refrigerants. In addition, a set of calibrated weighing scales shall be available and in good working order. Hoses shall be complete with leak-free disconnect couplings and in good condition. Before using the recovery machine, check that it is in satisfactory working order, has been properly maintained and that any associated electrical components are sealed to prevent ignition in the event of a refrigerant release. Consult manufacturer if in doubt.

The recovered refrigerant shall be returned to the refrigerant supplier in the correct recovery cylinder, and the relevant Waste Transfer Note arranged. Do not mix refrigerants in recovery units and especially not in cylinders.

If compressors or compressor oils are to be removed, ensure that they have been evacuated to an acceptable level to make certain that flammable refrigerant does not remain within the lubricant. The evacuation process shall be carried out prior to returning the compressor to the suppliers. Only electric heating to the compressor body shall be employed to accelerate this process. When oil is drained from a system, it shall be carried out safely.

5.2 Warranty

Your heat pump is covered by warranty. For particular conditions of this warranty in terms of warranty period and subject please refer to your local regulations and/or agreement with your distributor, reseller or installer. Any action resulting in damage of the heat pump, property or other damage caused by improper usage of this product or in contrary with this Installation and user manual is excluded from warranty coverage.

Notes:

Notes:

Distributed by:

Manufacturer:



MICROWELL, spol. s r.o.
SNP 2018/42, 927 01 Sala, Slovakia



tel.: +421/31/770 7082



e-mail: microwell@microwell.sk

www.microwell.eu

